

Toyota/Lexus Steering Angle Sensor (SAS) By CAN interface

I. Overview

The Steering Angle Sensor (**SAS**) is structurally connected to the airbag with a **flexible ribbon cable**, so that if the steering wheel is turned more than 2.5 revolutions, the sensor considers that the cable has broken and records an indelible error in its memory (further in the document crash data).

Under normal circumstances, such a situation is impossible, but often during vehicle repairs it becomes necessary to remove the steering wheel. This does not cause a malfunction if the sensor maintains its position relative to the steering shaft and steering wheel. If the relative position is changed over 2.5 turns in either direction a crash data record will be stored in the SAS's memory.

Note: If the SRS ribbon cable is damaged, it should be restored!

Supported SAS types

Current Barracuda software version (34) supports **2nd (uPD703230 + 93C66), 3rd(R5F2134AWJ) & 4th (R5F10PLJL)** generations of **Toyota / Lexus SAS** made by **Tokai Rika**. All work is done on the bench via CAN interface. Some common part numbers by generation:

SAS Num.	Manufacturer	MCU
89245-02060	Tokai Rika	R5F2134AWJ (Renesas R8C)
89245-06110	Tokai Rika	R5F10PLJL (Renesas RL78/F14)
89245-0D030	Tokai Rika	uPD703230 (NEC V850/ES) + 93C66
89245-0R030	Tokai Rika	R5F2134AWJ (Renesas R8C)
89245-0T010	Tokai Rika	uPD703230 (NEC V850/ES) + 93C66
89245-12040	Tokai Rika	R5F2134AWJ (Renesas R8C)
89245-12050	Tokai Rika	R5F2134AWJ (Renesas R8C)
89245-33080	Tokai Rika	R5F10PLJL (Renesas RL78/F14)
89245-50040	Tokai Rika	R5F10PLJL (Renesas RL78/F14)
89245-50100	Tokai Rika	R5F10PLJL (Renesas RL78/F14)
89245-74010	Tokai Rika	uPD703230 (NEC V850/ES) + 93C66

Requirements

- Barracuda programmer (function is available to all users in Base Software)
- J2534 compliant PassThru OBD Adapter (ex.: Tactrix OpenPort 2.0)
- 12V external power supply

II. Operating procedure

1. Connect SAS to the CAN adapter and supply 12V power.

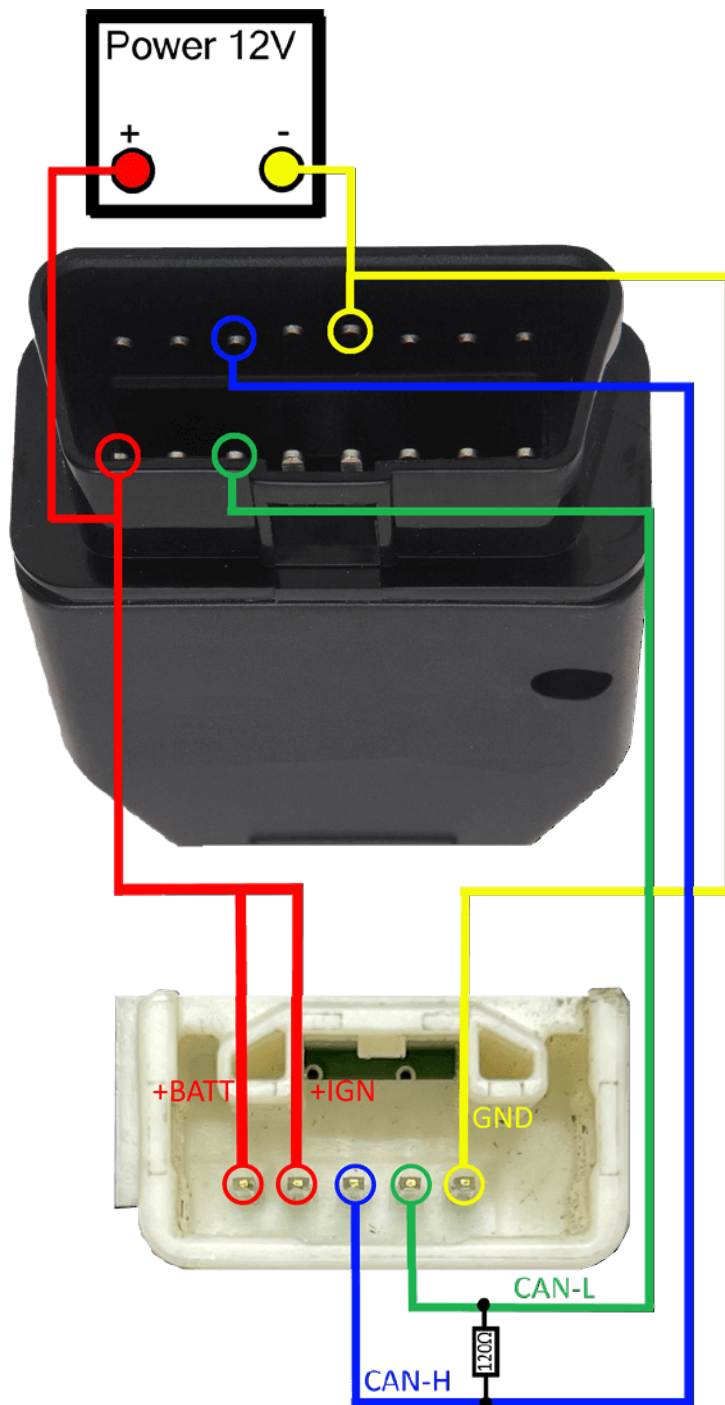

*In the example above is connector of second generation Tokai Rika SAS.
Pinouts for the other types are available in section III. **Connection Diagrams***

2. Start Barracuda and select **ECU Maker** -> **Toyota** -> **SAS** -> **Tokai Rika**
3. Press **Connect to SAS**
4. If crash data is present read will look similar to this :

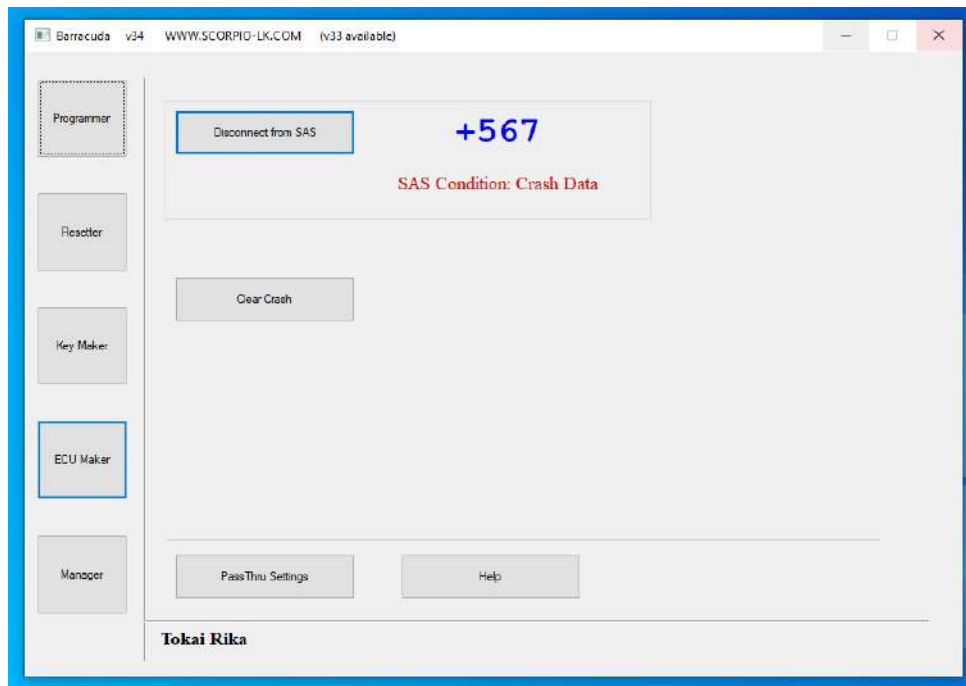

5. Press the **“Clear Crash”** button and turn the sensor wheel. You need to get the text SAS Condition: OK. Sometimes you need to repeat this step 3-5 times. If SAS Condition is still reported with Crash Data then turn the sensor wheel by a quarter ($\frac{1}{4}$) turn and press the **“Clear Crash”** button again. This is what the window looks like if the crash error is cleared:

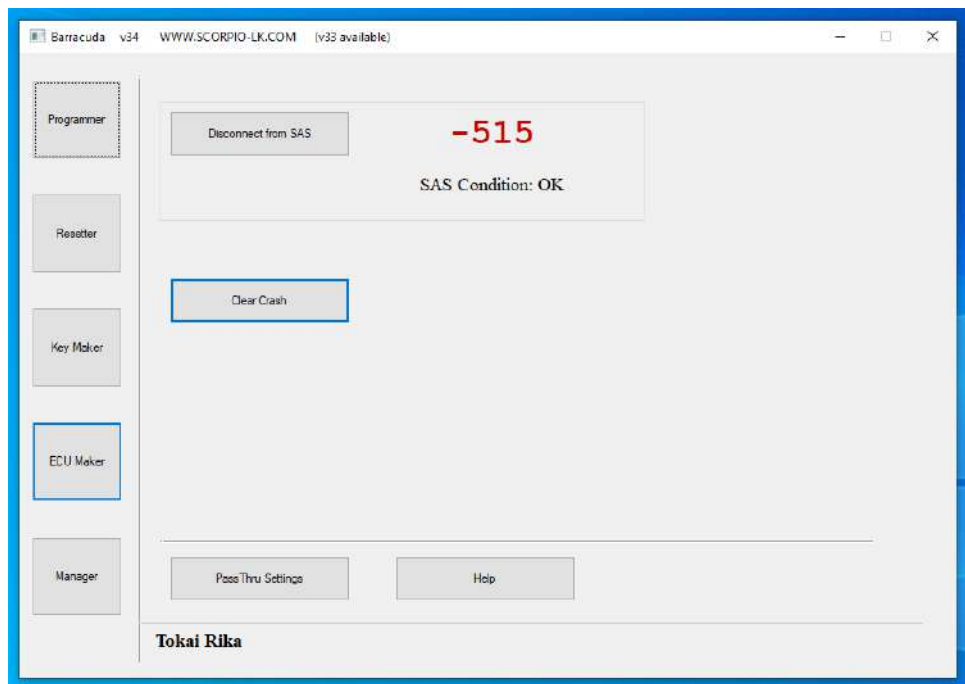

The actual value (in the example -515, +567) is not relevant at this point, what matters is the condition status.

6. After step 5. Is complete set the sensor rotation angle to **0 (central position)**. To do this, turn the sensor wheel and observe the numbers in the program window. When you turn the wheel, the program shows the angle of rotation. Note that the numbers are displayed in two colors, **blue** and **red**. If the sensor is turned to the **left** of the central position, the color will be **blue**, and if to the **right**, then **red**. Once center position is reached the angle value displayed is **0**. Note that it takes 11 full revolutions to get back to the position the process was started from (ex. **-515**, after 11 revolutions goes back to **-515**)

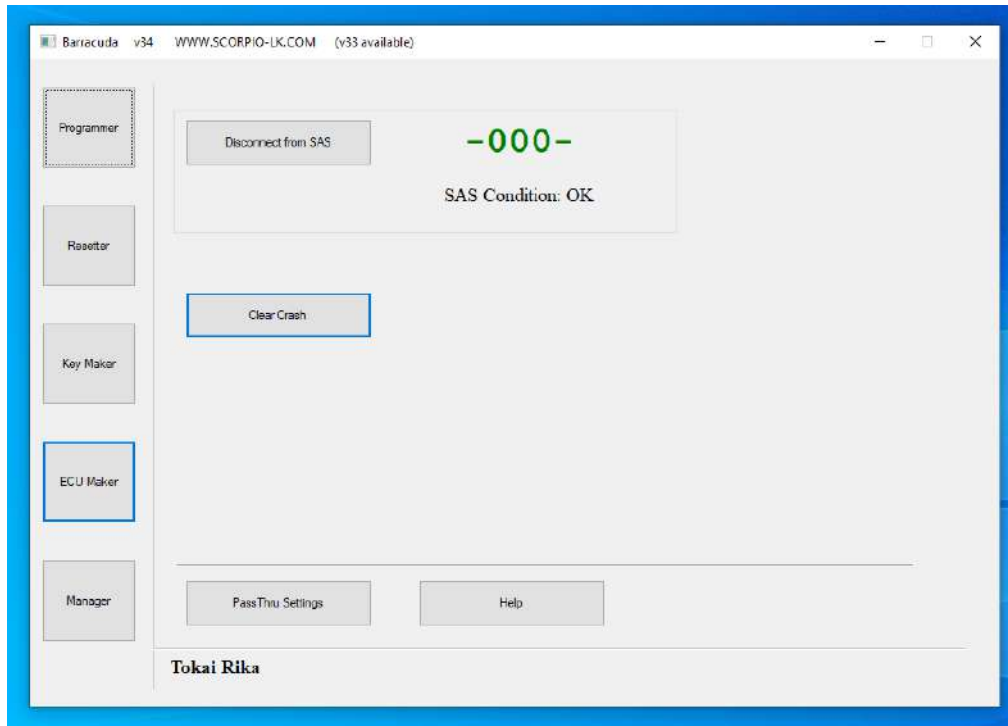

7. Make sure that the locking teeth inside the sensor wheel are positioned vertically, with the **wide tooth on top** and the **narrow tooth on the bottom**, as in the picture.

The mechanism is easily rotated and thus prone to misalignment. Once it was zeroed and both teeth are aligned we highly recommend to use tape in order to fix them into place before installing the sensor back to the vehicle.

If the wheel is in a different position, repeat steps 5., 6., 7..

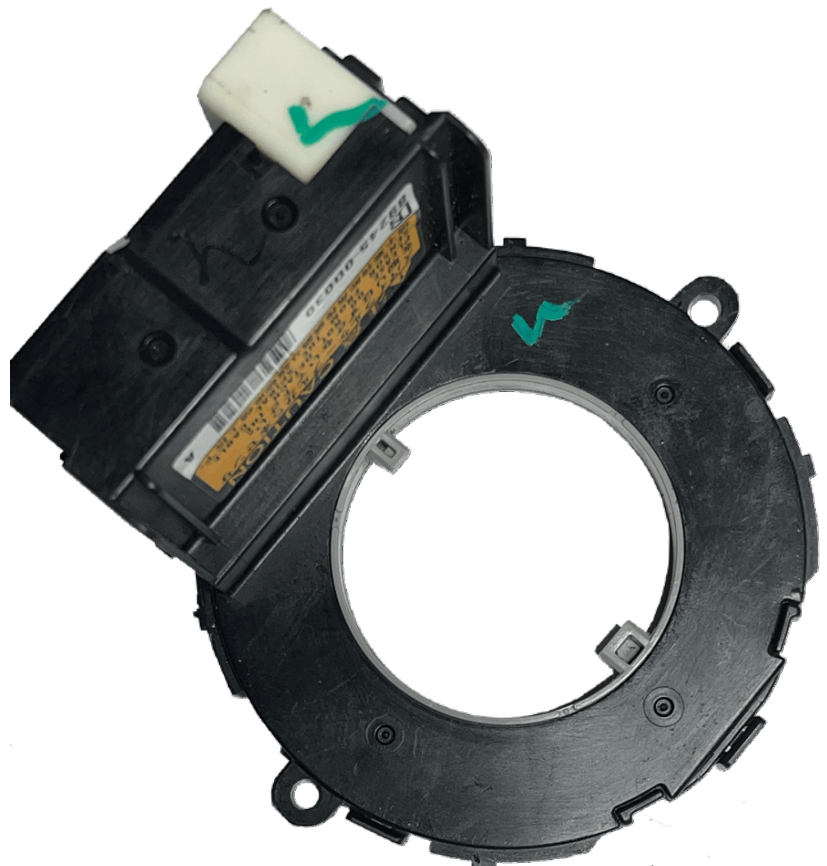

III. Connection Diagrams

1. 2nd Generation uPD703230 (NEC V850/ES)+ 93C66 :

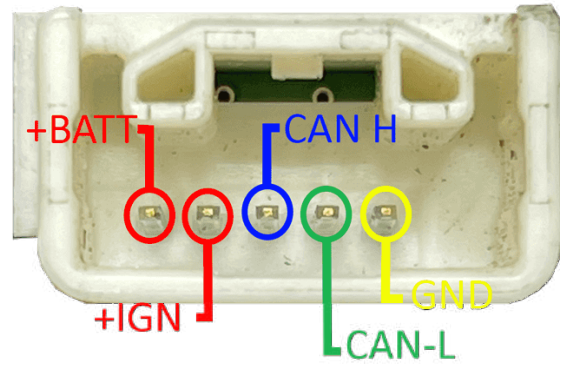
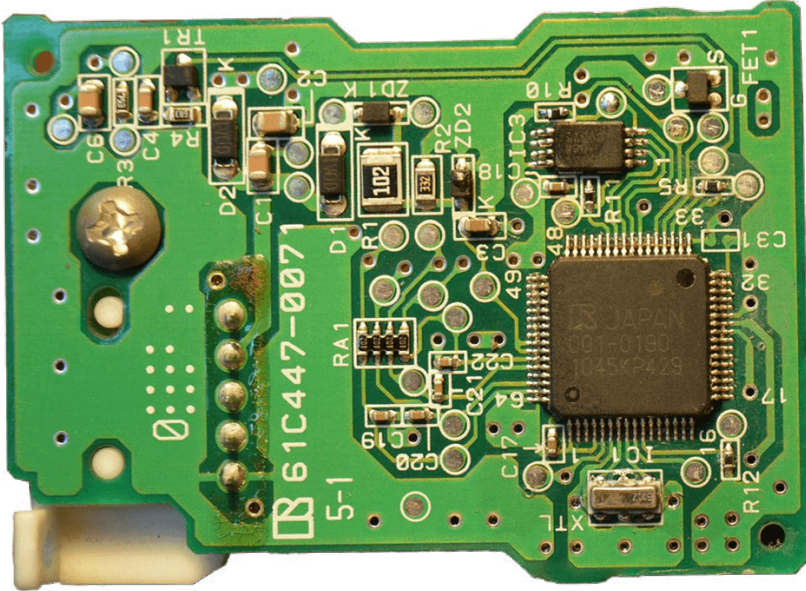

2. 3rd Generation R5F2134AWJ (Renesas R8C):

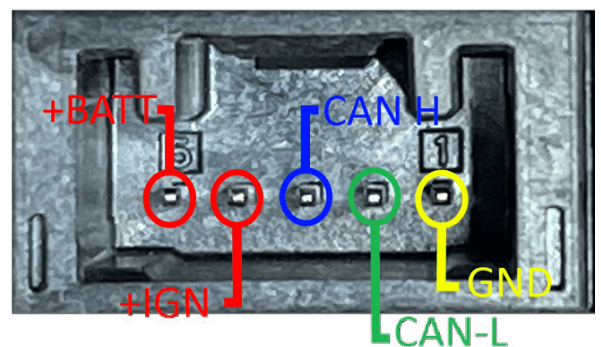
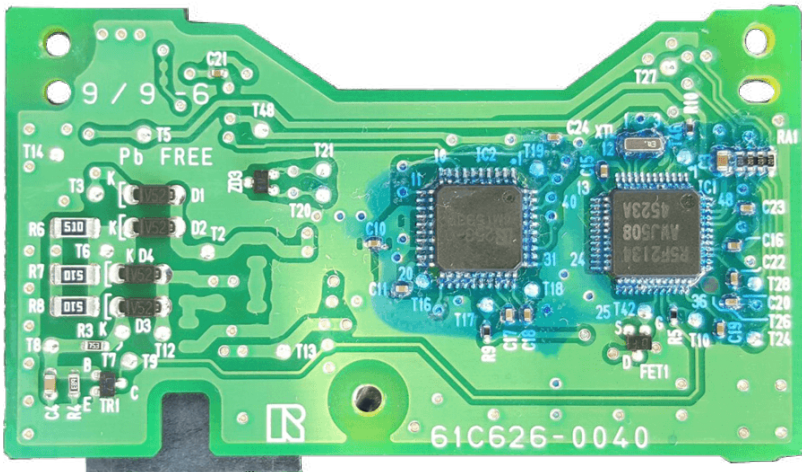

Note : There are 3rd Generation SAS based on **R5F2154** MCU, they are currently not supported. Attempts to reset their crash data may irreversibly brick the unit.

3. 4th Generation R5F10PLJL (Renesas RL78/F14) :

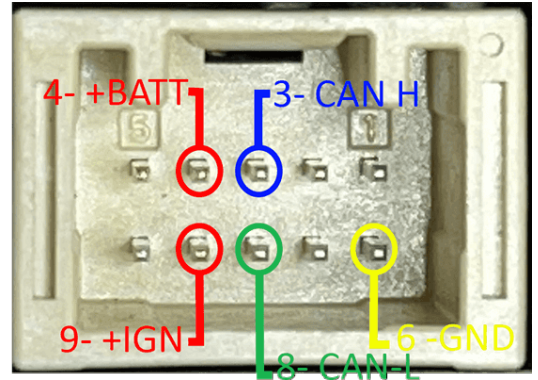
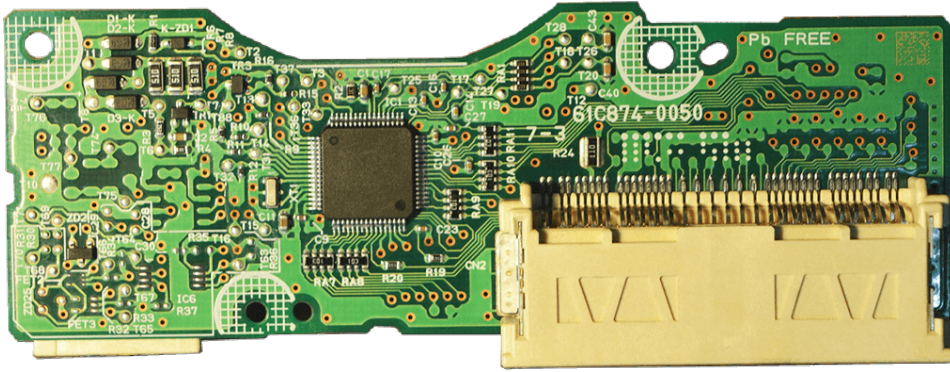

IV. Appendix

Tokai Rika Logo :

